









NEWALL



DP700 Digital Readout

User Manual

Contents

Specification	Page 3	
Electrical	Page 3	
Physical	Page 3	
Environment	Page 3	
Accreditation	Page 3	
Disposal	Page 3	
Input and Resolution	Page 3	
Mounting Options	Page 4	
Mill Mount	Page 4	
Lathe Mount	Page 4	
Adjustable Mount	Page 4	
Panel Mount	Page 4	
Connection Details	Page 5	
Important Information	Page 5	
Connections	Page 5	
Display and Keypad	Page 6	
Understanding the Display	Page 6	
Understanding the Keypad	Page 6	
Setting up the Unit	Page 7	
Navigating Complete Setup	Page 7	
Navigating Complete Setup (Continued)	Page 8	
Language Setup	Page 9	
Type Setup	Page 9	
Encoder Type Setup	Page 9	
Encoder Resolution Setup	Page 9	
Direction of Travel Setup	Page 10	
Radius / Diameter (Measure Setup)	Page 10	
Zero Approach Setup	Page 10	
Zero Approach Limits	Page 10	
Error Compensation	Page 11	
Linear Error Compensation	Page 12	
Linear Error Compensation Setup	Page 13	
Segmented Error Compensation	Page 14	
Segmented Error Compensation Setup	Page 14/15	
Plane Setup	Page 15	
Functions Setup	Page 16	
Beep Setup	Page 16	
Sleep Setup	Page 17	
Reset Setup	Page 17	
Standard Functions	Page 18	
Absolute / Incremental	Page 18	
Inch / mm	Page 18	
Zero and Preset an Axis	Page 19	
Undo Function	Page 19	
1/2 Function / Centre Find	Page 20	
Reference	Page 20	
Sub Datums (SDM)	Page 21	
RS232 Connections	Page 22	
RS232 Setup	Page 22/23	
RS232 Output Data Format	Page 24	
Mill Functions	Page 25	
Pitch Circle Diameter (PCD) / Bolt Hole	Page 25	
Line Hole	Page 26	
Arc Contouring	Page 27	
Polar Co-ordinates	Page 28	
Lathe Functions	Page 29	
Tool Offsets	Page 29/30	
Multiple Tool Datums	Page 31	
Taper	Page 32	
Summing	Page 32	
Trouble Shooting	Page 33	

Specification

Electrical

EU Directive 73/23/EEC (Low Voltage Directive)
BS EN 55022:1998 Class B
BS EN 55024:1998

Input to Power Supply Unit (Supplied)
100-240V (47-63Hz)
External switch-mode - Output voltage 15VDC
Input Voltage to DP700 15-24VDC $\pm 10\%$
Conforms to Low Voltage Directive

Physical

Height	170mm (6.69")	Depth	48mm (1.89")	Mounting Bolt: M10
Width	260mm (10.23")	Weight	1.5kg (3.3lb)	

Environmental

Climatic Range	Storage Temperature	-20°C to 70°C
	Working Temperature	-10°C to 50°C
	Working Humidity	95% R.H. at 31°C
IP-Ingress Protection	IP54 Panel Mount	
	IP40 Stand Alone	

Accreditation

CE

Disposal

At the end of its life, you should dispose of the DP700 system in a safe manner applicable to electrical goods

Do not burn

The casework is suitable for recycling. Please consult local regulations on disposal of electrical equipment

Input & Resolutions

Only Spherosyn or Microsyn encoders can be used with the DP700 DRO

Resolutions

Spherosyn 2G or Microsyn 10	Microsyn 5
5 μ m (0.0002")	1 μ m (0.00005")
10 μ m (0.0005")	2 μ m (0.0001")
20 μ m (0.001")	5 μ m (0.0002")
50 μ m (0.002")	10 μ m (0.0005")

Newall Measurement Systems Limited reserves the right to make changes to this specification without notice

Mounting Options

This chapter details the various mounting options for the DP700, both the standard version and the panel mount version.

Mill Mount (Non Adjustable)



Lathe Mount (Non Adjustable)



Adjustable Mount Options

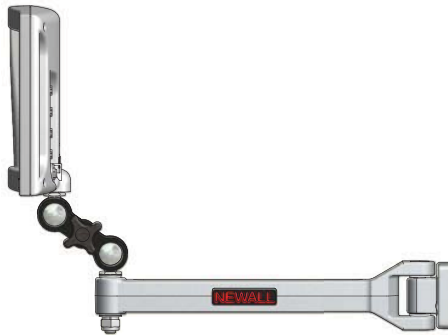

Panel Mount Option

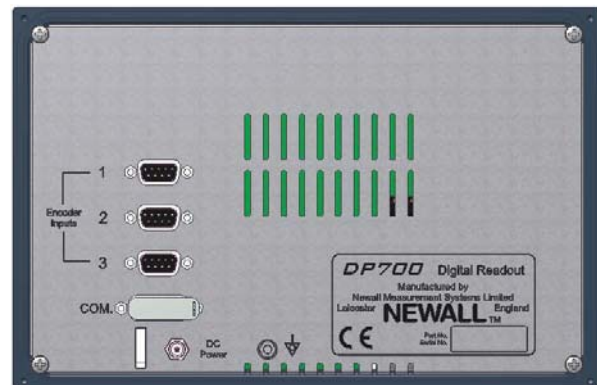
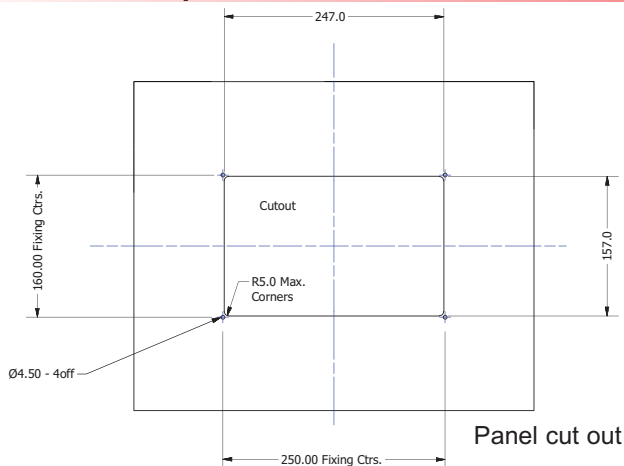

Connection Details

This chapter details the cable connections for the DP700.

Important Details

You can only use the DP700 with Newall Spherosyn and Microsyn analogue encoders.

You need to ensure that:

- ✓ You secure all the cables to prevent the connectors from dropping into hazardous positions (for example the floor or coolant tray) when you unplug them.
- ✓ You route all cables to prevent them from being caught on moving parts.
- ✓ The DP700 is grounded to the machine, using the braided grounding lead provided, before you turn on the machine supply.
- ✓ The power has been disconnected, before you connect the encoder(s).

Do not connect this unit directly to the mains supply.

If your Newall encoder has a round 7 pin connector, then you can buy an adaptor cable (part no. 307-80980). Contact your local Newall supplier for details.

Connections

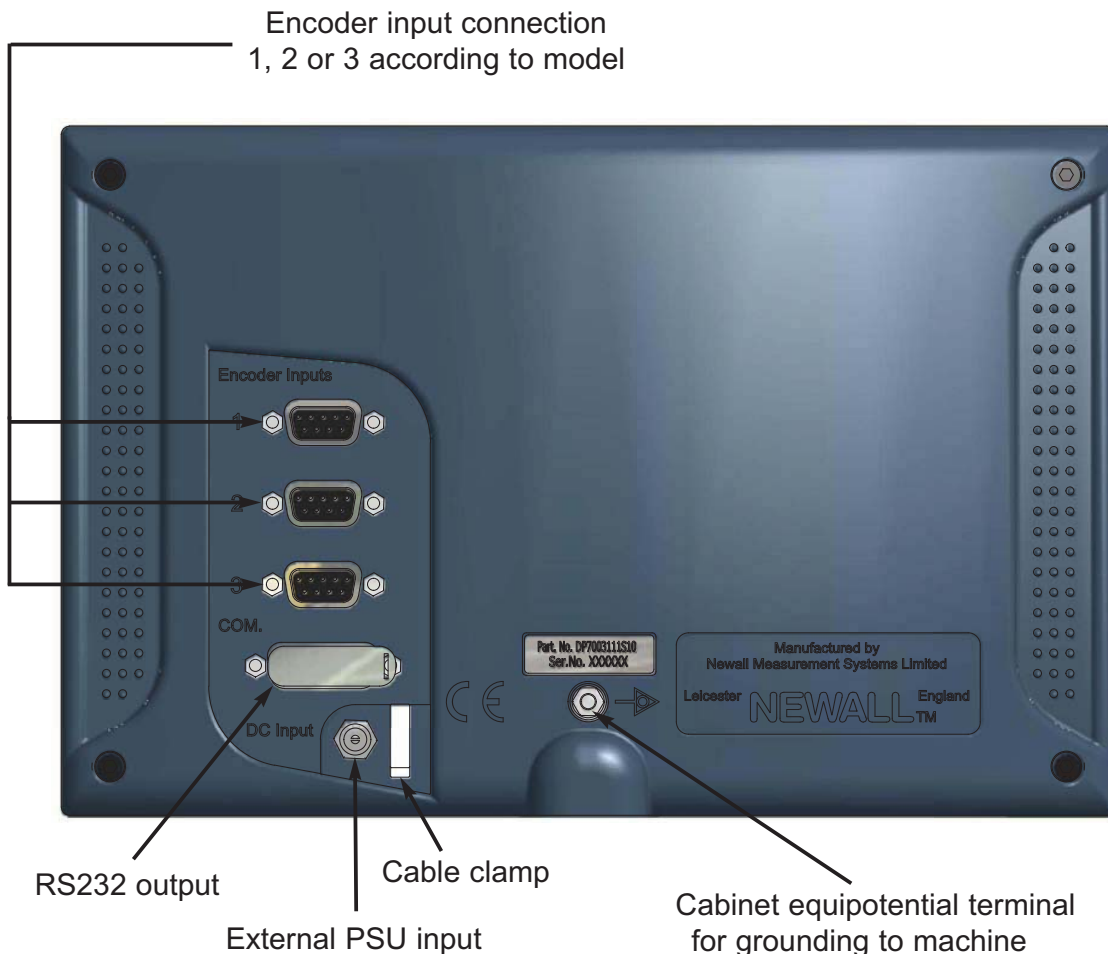

Display and Keypad

This chapter explains how to interpret the display and use the keypad.

Understanding The Display

Feed Rate Display: mm per second for mm mode, inches per minute for inch mode



Understanding The Keypad

	Axis Selection Key		Digifind / Reference
	Numeric Keys		Switches between Zero and Axis Preset modes
	Enter Key		Switches between Absolute and Incremental modes
	Clear Numeric Entry		Switches between Inch and mm display
	Centre Find		Information selection (scrolls through options on Message display)
	Undo Key		Function Menu Key
			Function Navigation Keys

Setting Up The Unit

Navigating Complete Setup

How to enter setup

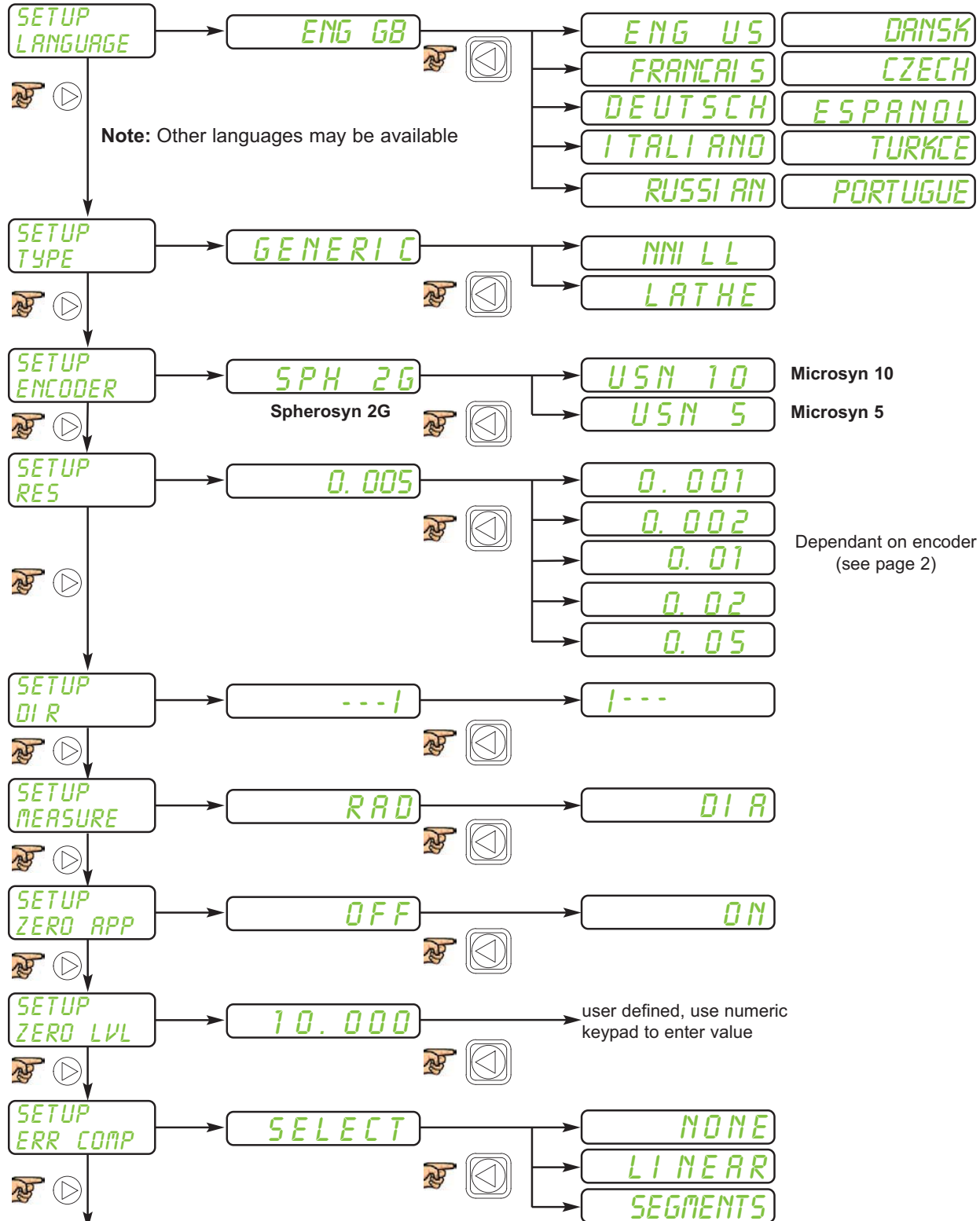

Setting Up The Unit

Navigating Complete Setup (continued)

Only applicable to 3 axes units

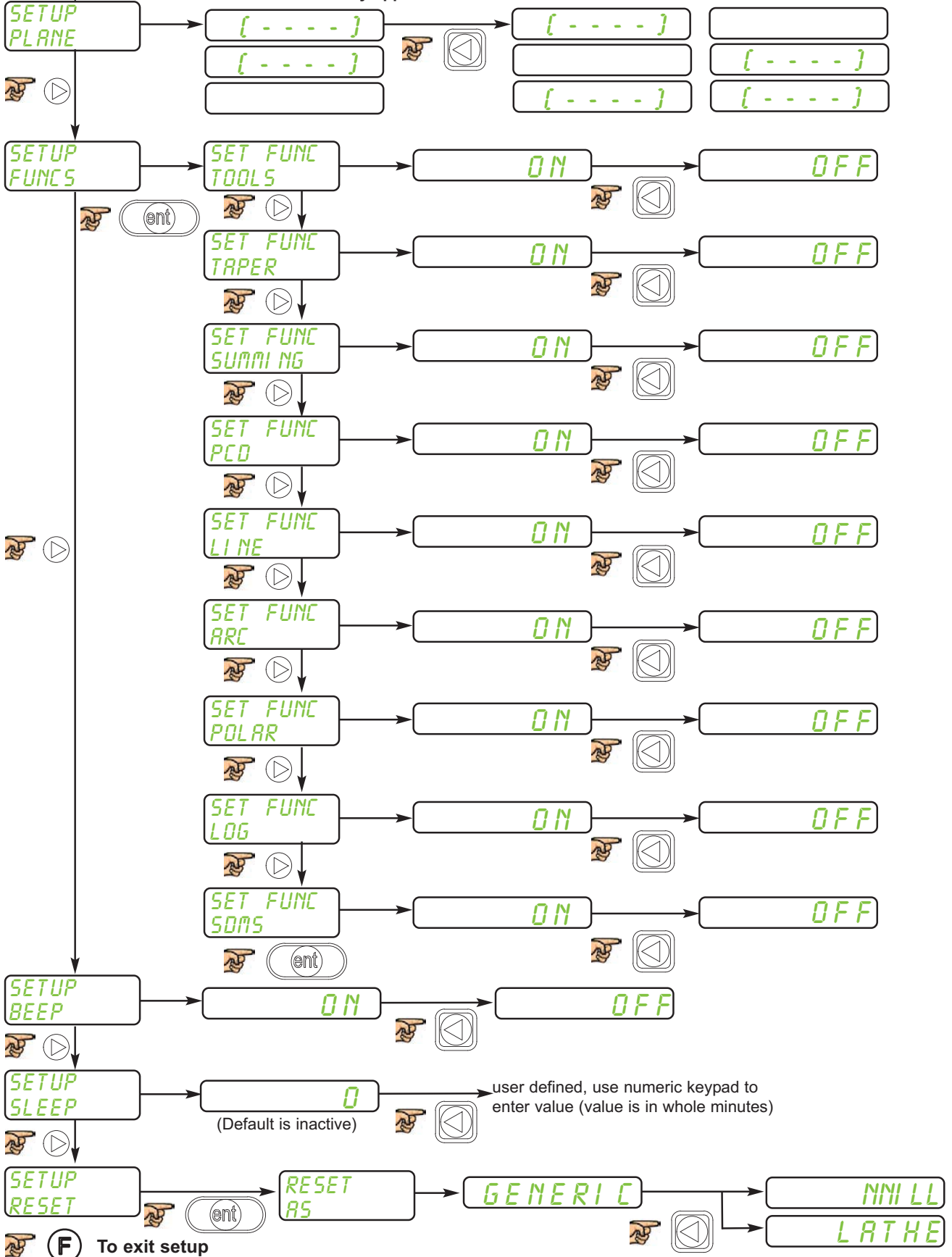











Setting Up The Unit

Language Setup

This setting enables the user to choose the language that is required to be displayed in the DP700 display.

There are 11 language settings:

	English UK (Default)		Danish		Russian
	English US		Portuguese		Czech
	French		Spanish		
	German		Turkish		
	Italian				



Note: Other languages may be available

Press the axis select key  next to the 'X' axis to cycle through options

Type Setup

This setting enables the user to choose the machine type that the DP700 operates in.

There are 3 settings:

Press the axis select key  next to the 'X' axis to cycle through options



Note: When set to lathe the x axis changes to diameter measurement

Note: When set to lathe or mill some functions are automatically turned off

Encoder Type Setup

The encoder settings must match the actual encoder in use, or the DP700 will not measure correctly

Newall manufacture 3 types of encoders to work with your DP700:

Spherosyn 2G	
Microsyn 10	
Microsyn 5	

Press the axis select key  next to the 'X', 'Y' or 'Z' axis to cycle through options

Encoder Resolution Setup

The resolution settings available for each axis depend on the encoder type and the inch/mm setting.

µm	Display		Spherosyn™ 2G	Microsyn™ 10	Microsyn™ 5
	mm	in			
1	0.001	0.00005			✓
2	0.002	0.0001			✓
5	0.005	0.0002	✓	✓	✓
10	0.01	0.0005	✓	✓	✓
20	0.02	0.001	✓	✓	
50	0.05	0.002	✓	✓	

Press the axis select key  next to the 'X', 'Y' or 'Z' axis to cycle through options

Setting Up The Unit



Direction of Travel Setup

You use the direction setting to match the DP700 to the actual direction of travel of any axis.

There are two settings for each axis  and 

Press the axis select key  next to the 'X', 'Y' or 'Z' axis to cycle through options

Example

If the current setting is  and the travel is positive from right to left, changing the setting to  will reverse the direction to measure positive from left to right.

Radius / Diameter (measure Setup)

The radius/diameter function allows the operator to display actual (radius) or twice-actual (diameter) measurements for each axis.

This function is generally used in turning applications, such as the cross travel on a lathe where you want to display the diameter reading rather than the radius.

There are two settings for each axis:

Radius 

Diameter 

Press the axis select key  next to the 'X', 'Y' or 'Z' axis to cycle through options

Zero Approach Setup

This setting provides a visual indication that one or more axes are approaching zero. It does this by using the far left LED segment on each axis, as the axis approaches zero each segment of the '0' lights up in quick succession. Once zero has been reached the '0' in the far left will be constantly on.

There are two settings for each axis:

Zero approach on 

Zero approach off 

Press the axis select key  next to the 'X', 'Y' or 'Z' axis to cycle through options

Zero Approach Limits



This setting allows you to choose how close to zero the axis needs to be before the zero approach function takes effect

Press the axis select key  next to the 'X', 'Y' or 'Z' axis

Display shows  as standard

Example

To change zero approach limits to 5mm

Press  then  display shows 

Now when you cross 5mm approaching zero, the feature will be activated.

Setting Up The Unit

Error Compensation

Your digital readout (DRO) system helps you to improve productivity. It decreases the number of scrapped parts, as you no longer have to be concerned about making mistakes related to counting the revolutions on the dials. Your DRO system also helps to eliminate some errors related to ballscrew backlash.

Your DRO system will operate to its published accuracy, provided all components are in working order and properly installed. Field calibration is not necessary.

Accuracy problems with machined parts may be caused by machine error, DRO system error, or a combination of both. The first step in determining the source of error is to check the DRO system. You do this by comparing the movement of the Newall reader head to the position reading shown on the display. You need a high accuracy standard, such as a laser interferometer. You can use a dial indicator to check short distances, but a laser provides the best results. If you have to use a dial indicator, be sure it is the highest available accuracy.

To check the accuracy of the DRO system:

1. Place the target of the laser or the needle of the dial indicator directly on the Newall reader head. It is absolutely critical that you take the readings directly from the Newall reader head. If you have to use a dial indicator, be sure that the needle of the indicator is perpendicular to the reader head and not angled. If you take readings anywhere else on the machine, machine errors may distort the results.
2. When the reader head moves, the movement registers on the laser / indicator and DRO display.
3. Set the laser / dial indicator and DRO position displays to 0.
4. Make a series of movements and compare the position readings between the laser / dial indicator and the DRO display. If the readings match within the accuracy specified, then you know that the DRO system is operating properly. If this is the case, you can proceed to the next step: evaluating the machine errors. If the readings do not match, you must repair the DRO system before proceeding with error compensation.

To evaluate machine errors:

1. Put the laser target / dial indicator on the part of the machine where the machining is done.
2. Make a series of movements and compare the position readings between the laser / dial indicator and the DRO display. The difference between the laser / dial indicator reading and the reading on the DRO display is your machine error.
3. Plot the machine error along the entire axis of travel to determine the nature of the error. If it is a linear error, you can use linear error compensation. If the error is not linear, you should use segmented error compensation.

Setting Up The Unit

Types of Machine Error

There are many types of machine error, including pitch, roll, yaw, flatness, straightness, and Abbé error. The diagrams below demonstrate these errors.

Way errors

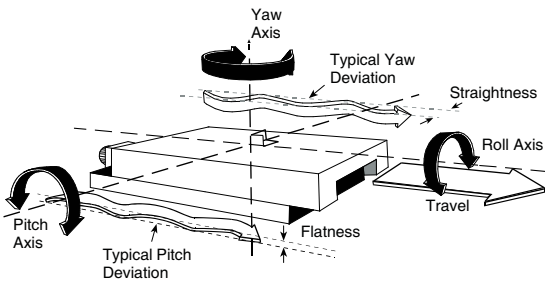

Abbé error

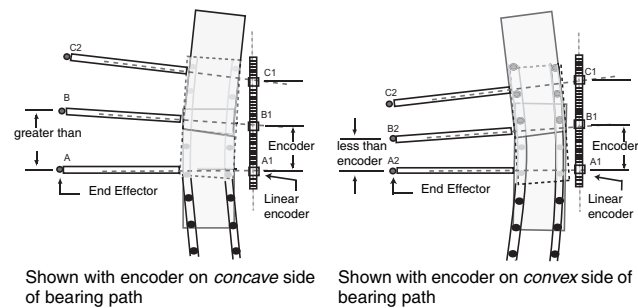

Linear Error Compensation

In this mode, you can apply a single constant correction factor for each axis to all displayed measurements. You calculate the correction factor, and specify it in parts per million (ppm). In this mode a single constant correction factor for each axis is applied to all displayed measurements.

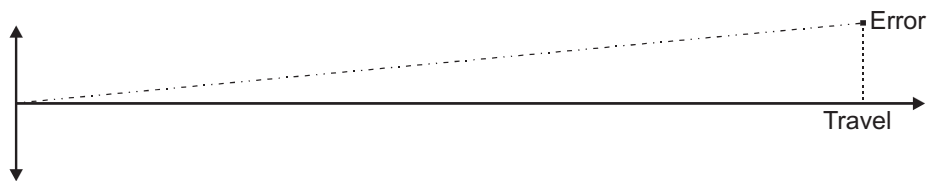

As you follow the procedure you must ensure that you either use a stepped standard, and approach each edge from the same direction; or if you must approach each edge from opposite directions, then subtract the width of the tool or measuring probe from the value displayed on the DP700.

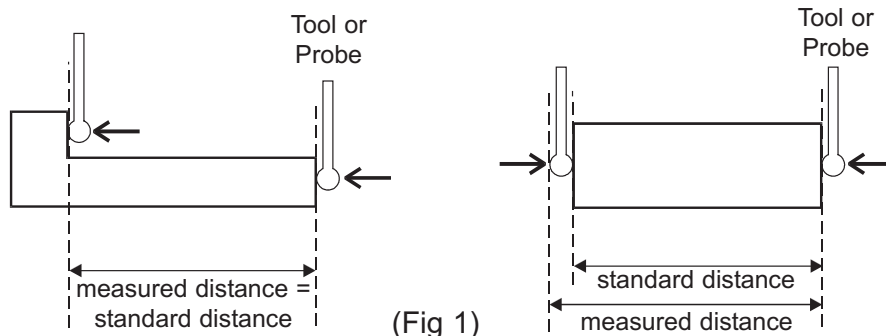

Setting Up The Unit

Linear Error Compensation Setup

This setting allows you to setup compensation factors for linear errors. There are two methods of entering compensation values **Teach mode** and **Program mode**.

Teach Mode



Teach mode is an easier way of calculating linear errors by using the DP700 to automatically calculate the error, by comparing the actual measurement and the physical movement. The procedure to do this is shown below.



Error comp select screen is displayed



Press the axis select key  next to the 'X', 'Y' or 'Z' axis which requires linear compensation

Press the   key to Navigate to **Linear**. Press 

Press the   key to Navigate to **Teach**. Press 

Display Shows  Move tool / probe to start position (see fig 1) Press 

Display Shows  Move tool / probe to end position (see fig 1) Press 

Display Shows  Enter the actual measurement using numerical keypad Press 

Display Shows  Press  to accept, or  to decline

If accepted, goes back to error comp select screen

Program Mode

First you must determine the correction factor required. To do this you use the following equation. (In the following example the standard distance is 500.000mm and the measured distance is 500.200mm.)

$$\text{Correction factor} = \text{error} / \text{actual} \times 1,000,000$$

$$\text{Correction factor} = (500 - 500.200) / 500.000 \times 1,000,000$$

$$\text{Correction factor} = -400$$

Error comp select screen is displayed

Press the axis select key  next to the 'X', 'Y' or 'Z' axis which requires linear compensation

Press the   key to Navigate to **Linear**. Press 

Press the   key to Navigate to **Program**. Press 

Display Shows 

Enter -400 from the example above using the numeric keypad Press 

Goes back to error comp select screen

Setting Up The Unit

Segmented Error Compensation

The scale travel is broken down into as many as 200 user-defined segments, each with their own correction factor, measured against a high-accuracy standard. The following parameters need to be identified:

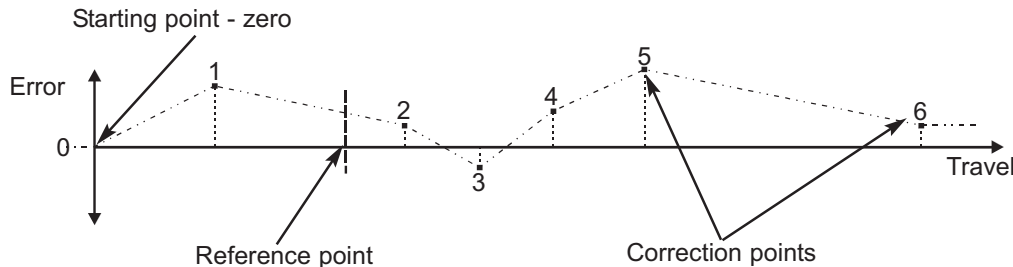

Each Correction Point is measured with respect to the Starting Point - zero - which is usually set close to one end of the scale. The Reference Point can be set anywhere along the scale, and does not need to coincide with either the absolute datum or any of the correction points. However, it may be convenient to make the absolute datum and the reference point the same.

Always approach the Starting Point, Correction Points and Reference Point from the same direction. If you do not, then the size of the tool or probe will render the measurement inaccurate.



Segmented Error Compensation Setup



Procedure for setting segmented error compensation



Error comp select screen is displayed



Press the axis select key  next to the 'X', 'Y' or 'Z' axis which requires segmented compensation

Press the   key to Navigate to **Segments** Press

Display Shows  Set machine to reference point Press 

Display Shows  Move tool / probe to zero Press 

Display Shows  Move tool / probe to first position Press 

Display Shows  Enter the actual measurement using numerical keypad Press 

Display Shows  Press  to accept, or  to decline

Display Shows  Press  to move to next point, or  to finish

Goes back to error comp select screen

Setting Up The Unit

Segmented Error Compensation Setup (continued)

Note. When using Segmented error, each time you turn on the DP700 you need to move to the machine reference point. The DP700 will prompt you for this on power up, see below.

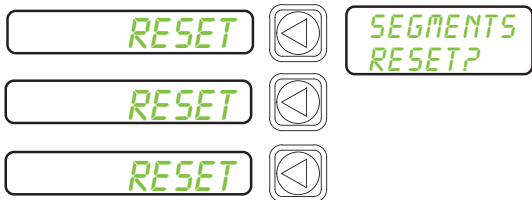

Note. Reset will only appear on an axis if segmented error has been implemented

Move each axis to the reference point and then press  next to the axis in question

Once all axes have been reset to reference the DP700 will go into normal operating mode

Plane Setup

This setting enables the user to choose the plane in which certain functions will operate. The plane consists of two axes that require to be set for certain functions to operate correctly.

There are three possible settings:

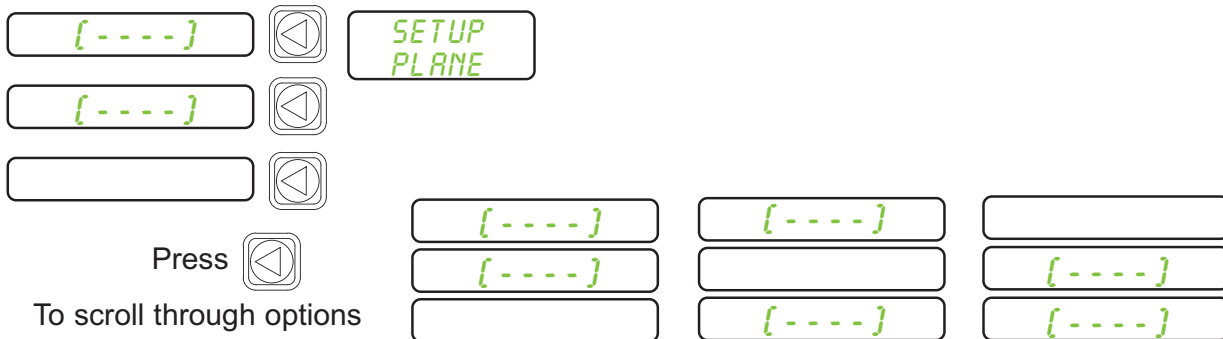

Press  To select the chosen plane

Note: Only applicable to a 3 axes unit

Setting Up The Unit

Functions Setup

This setting enables the user to choose the functions that are required to be used with the DP700. Functions that are switched off will not show in the function menu or message display.

Function On

Function Off

Press the axis select key  next to the 'X' axis to cycle through options

Press the   key to Navigate through functions

the list of functions can be found below

<input type="text" value="SET FUNC
TOOLS"/>	Tool Offsets
<input type="text" value="SET FUNC
TAPER"/>	Taper
<input type="text" value="SET FUNC
SUMMING"/>	Axes Summing
<input type="text" value="SET FUNC
PCD"/>	Pitch Circle Diameter / Bolt Hole Circle
<input type="text" value="SET FUNC
LINE"/>	Line Hole
<input type="text" value="SET FUNC
ARC"/>	Arc Contouring
<input type="text" value="SET FUNC
POLAR"/>	Polar Co-ordinates
<input type="text" value="SET FUNC
LOG"/>	RS232 Data Logging
<input type="text" value="SET FUNC
SDMS"/>	Sub Datums

press  to exit

Beep Setup

This setting enables the user to have the option of an audible tone on pressing any of the keys on the DP700.

There are two settings:

Key Beep on

Key Beep off

Press the axis select key  next to the 'X' axis to cycle through options

Setting Up The Unit

Sleep Setup

This setting enables the user to define an automatic sleep mode after a period of time. The user either leaves the default setting at 0 which deactivates the sleep mode, or inputs a value (in whole minutes) for when the sleep mode is initiated after no operation of the DP700.

To exit sleep mode, simply move an axis or press any key.

There are two settings:

Sleep Mode deactivated (Default)

Sleep Mode Active

Enter the required value via the numeric keypad, Press  to accept the value.

Note: The number in the display is the value in whole minutes before the DP700 will enter sleep mode.

Reset Setup

This setting enables the user to reset the DP700 unit back to factory defaults.

There are three factory default settings:

Default as Lathe / Mill

Default as Mill

Default as Lathe

Press the axis select key  next to the 'X' axis to cycle through options

Press  to accept the option.



Press the axis select key  next to the 'X' axis to cycle between yes and no.

Press  to accept.

Please note: When the DP700 is defaulted as a lathe the X axis default setting is DIA and therefore the X axis will measure double.

OEM Defaults: The DP700 may have OEM default settings specific to a machine. In this case the DP700 will only display one reset option. This reset will default all parameters to match the machine it has been provided with.

Standard Functions

This chapter details the standard functions of the DP700.

Absolute / Incremental

Press  to toggle between absolute and incremental mode

The DP700 has a dedicated key to switch the positional displays between absolute (abs) and incremental (inc) measurements. The current display mode is indicated by a red LED either above or below the key as shown right.

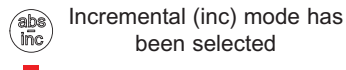
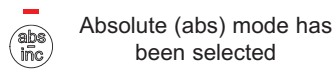

Using Incremental Mode

In Incremental mode the DRO displays the position relative to the last position. This is also known as point-to-point use. In this mode you can set the value for each axis, or zero it to create an Incremental datum. This does not effect the machine's Absolute datum that you configure in Absolute mode.

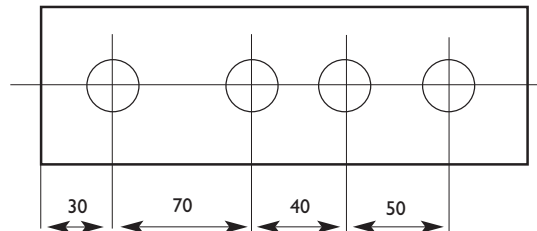

Using Absolute Mode

In Absolute mode the DRO displays the positions of all the axes with respect to a fixed datum. The datum is set by entering an axis position when in Absolute mode.

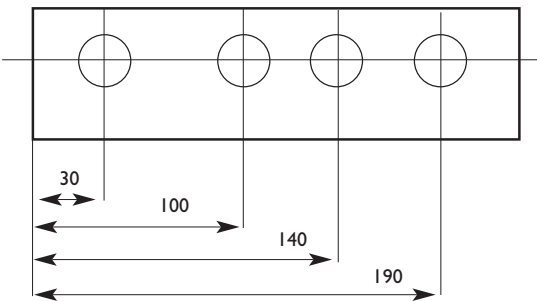

Example of Absolute and Incremental use

Set absolute zero at lower left corner of the part



Move to first position in ABS (Hole A)



Move to second position in ABS (Hole B)



Switch to incremental mode and zero the display



Make an incremental move to Hole C



Switch to absolute mode

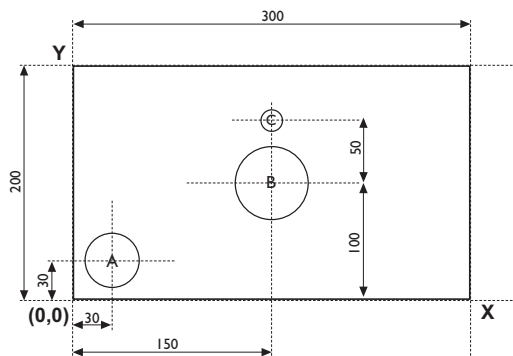

Inch and mm

Press  to toggle between Inch and mm mode

The DP700 has a dedicated key to switch the positional displays between imperial (inch) and metric (mm) measurements. The current display mode is indicated by a red LED either above or below the key as shown right.

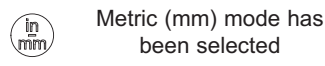
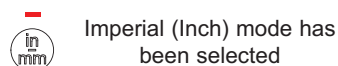

Standard Functions

Zero and Preset an axis

Press  to toggle between 'set' and 'zero' mode

The DP700 has a dedicated key to switch the operation of the axis selection key between zero mode and set mode. The currently selected mode is indicated by an LED either above or below the key as shown right.

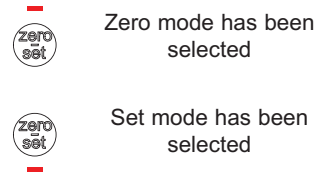

Using Set Mode

With set mode selected, this enables the select axis keys to prompt a numeric entry into the desired axis. Once the correct value has been selected, it can be set into the axis by pressing the enter key. This can be seen in the example on the right.

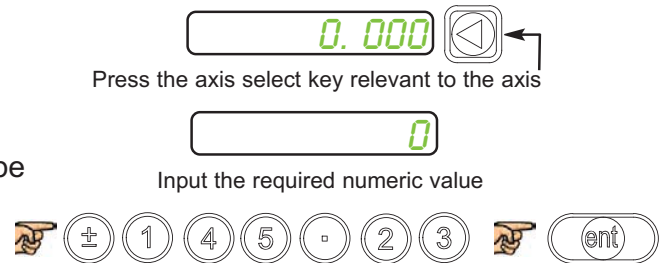

Zeroing an Axis in Set Mode

With set mode selected, it is possible to zero the axis conveniently by double pressing the relevant select axis key. This can make use of the DP700 zeroing and set modes much quicker and easier. This is shown in the example on the right.

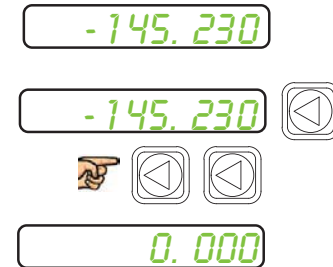

Using Zero Mode

With zero mode selected, this enables the select axis keys to zero each axis independently. This can be seen in the example on the right.

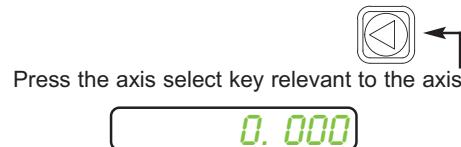



Undo Function

The DP700 stores the last 10 positions/numeric inputs, which can be accessed using the undo  feature



Example 1 - non movement



Display shows  input a value 

You have inputted an incorrect figure and want to get back to the dimension shown before

Press  Display now shows 

Example 2 - movement

input a value  move to that point, display now shows 

input a value  move to that point, display now shows 

Press  once, display now shows  this is the position of your second point

Press  again, display now shows  this is the position of your starting point

Standard Functions

Half Function / Centre Find

Press  to initiate the half function.

The DP700 has a dedicated key to half the value in any axis. This is done by initiating the half mode and selecting the required axis. This can be seen in the example on the right.

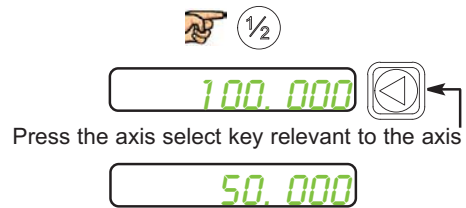

Digifind / Reference Function

The DP700 comes equipped with Digifind, a feature unique to Newall digital readout products. Digifind eliminates the risk of losing your position and datum Set-Up. With Digifind, precise Set-Up of a workpiece is carried out only one time.

When the DP700 is powered on, it displays the position at power off, compensated for any movement of a Spherosyn transducer up to 0.2500" (6mm) and a Microsyn encoder up to 0.1000" (2.5mm) in either direction since the unit was last used. If the machine has moved beyond 0.2500" (6mm) - Spherosyn [0.1000" (2.5mm) - Microsyn], Digifind allows a quick means to find the datum if lost.

A mark must be made on both a stationary part and moving part of the machine. The marks must be aligned and will serve as the machine "home" position.

The mark must be indelible, and it must allow the operator to move the machine to within a 0.2500" (6 mm) - Spherosyn [0.1000" (2.5mm) - Microsyn] band around the mark at any time. Alternatively, you can use a convenient reference point on the workpiece

Setting the reference

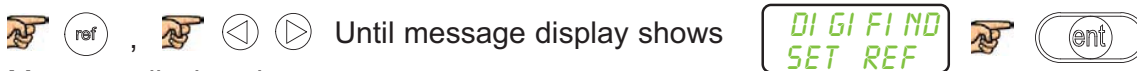

Message display shows



The reference point is now set

Finding the reference

If datum is lost at anytime it is possible to "Find" the datum again. Position the machine to within the 6mm (0.2500") band for Spherosyn and 2.5mm (0.1000") band for Microsyn. "Find" the reference.

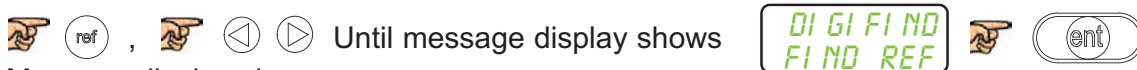

Message display shows



The position to the absolute zero for that axis is now displayed

Finding zero

As a fail safe, Digifind can 'find' the last datum or absolute zero set.

Position the machine to within the 6mm (0.2500") band for Spherosyn and 2.5mm (0.1000") band for Microsyn. "Find" the reference.

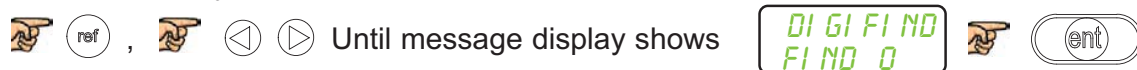

Message display shows



The original datum is reset

Standard Functions

Sub Datums / Memory

The DP700 can store up to 200 SDM (Sub-Datum) positions, or machining steps into the memory. Using SDM allows the operator to work to zero by calling up stored dimensions, instead of "working up" to drawing dimensions. This eliminates the need to constantly refer to the drawing, and reduces the possibility of scrapping parts due to misread dimensions. It also speeds up positioning because the operator works to zero.

The SDMs are stored as co-ordinates relative to the absolute datum position. If the absolute datum position changes, the SDMs will "shift" to the new datum.

Once a repetitive sequence of co-ordinates is entered into SDM, the co-ordinates can be recalled at any time. The positions remain in memory until altered by the operator. Simply assign any SDM number 1 - 200 to each machining step. When machining, call up each step (SDM) number and work to zero.

There are two ways to store Sub datums, Teach mode and program mode. See example below

How to navigate to Sub datum teach mode.

F , Until message display shows

Message display shows

Until message display shows

Move to first sub datum

Repeat until all sub datums have been entered

CE To return to main SDM menu

How to navigate to Sub datum program mode.

Until message display shows

Enter first sub datum points
(See using set mode P16)

Repeat until all sub datums have been entered

CE To return to main SDM menu

How to navigate to Sub datum use mode.

to scroll through sub datums or use numeric keypad to input sub datum required

CE To return to main SDM menu

F To return to exit SDM

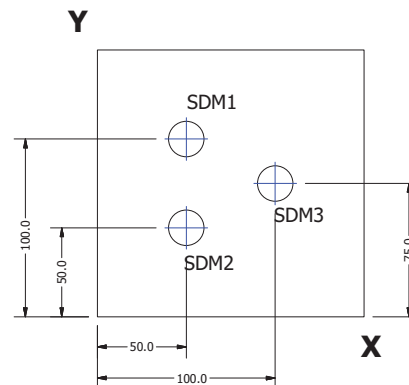

Standard Functions

RS232 (Data Logging) / Data Acquisition

The DP700 DRO can offer basic serial communications via a dedicated hardware RS232 compatible port, this is used for data logging purposes.

RS232 Connections

You connect the RS232 to the DP700 via a 15-pin D-type connector at the rear of the display. The required connection details to make this possible are shown below.

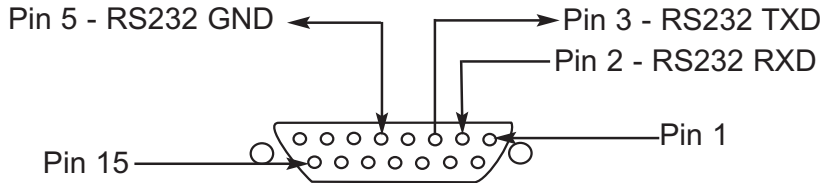

Serial cable available (part number 307-83210), Contact your local Newall supplier for details.

RS232 Setup

The diagram below shows the different menus that are applicable for different RS232 output selections (off, ent, periodic).

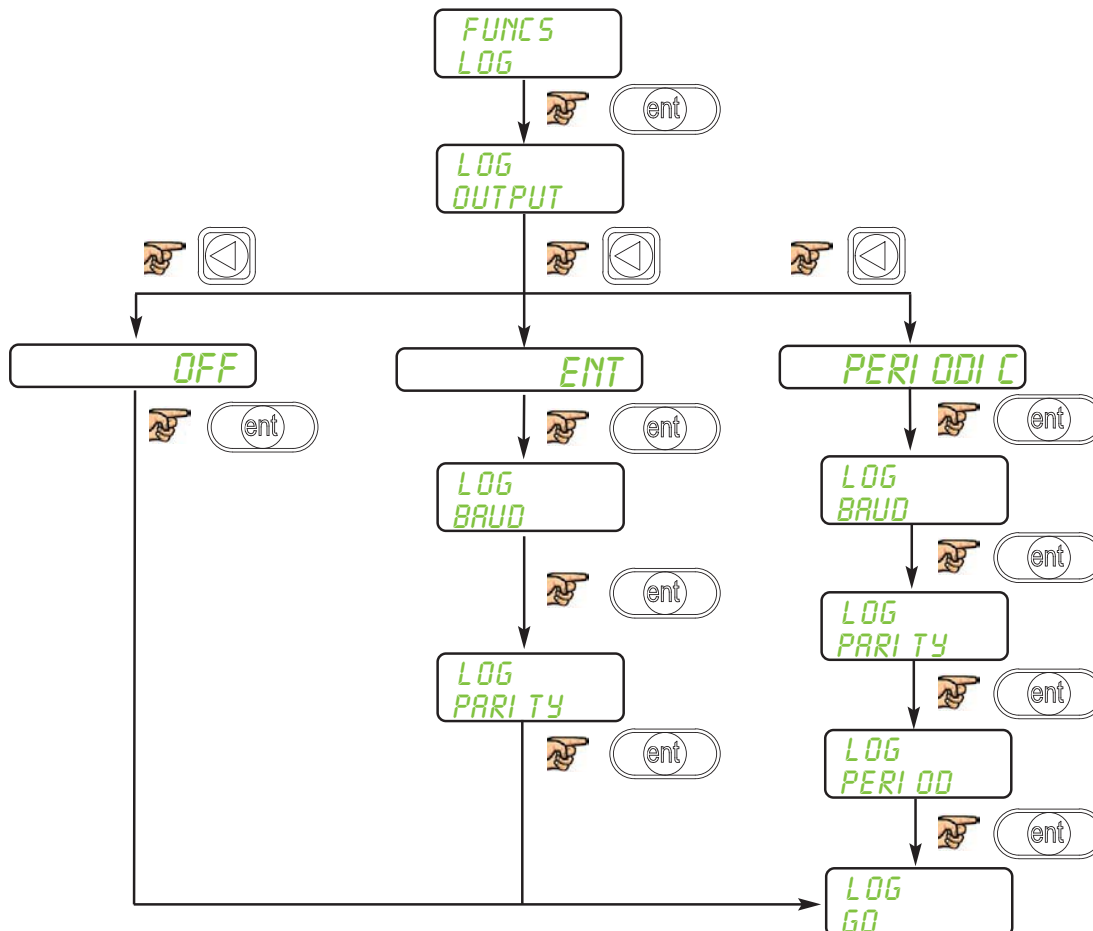

Standard Functions

RS232 Setup

How to navigate to RS232 setup.

F , Until message display shows

Message display now shows

Note: Relates to output options of the RS232 Communications

to scroll through output options. (**Off, ENT, Periodic**)

Once selected

Note: **Ent**, is for operating the RS232 on request. The enter key is pressed when the output is required.

Periodic, is for operating the RS232 at set intervals. The interval is defined in the RS232 setup.

When ENT or Periodic is selected

Message display shows

Note: Relates to baud rate of RS232 Communications

to scroll through baud rate options. (**300,1200,2400,4800,9600,14400,19200,38400,57600,115200,230400,460800,921600.**)

Once selected

Message display now shows

Note: Relates to parity mode of the RS232 Communications

to scroll through parity options. (**None, Even, Odd**)

Once selected

In the case **periodic** is selected, message display now shows

Note: Relates to period of output log for RS232 Communications (value in seconds)

Note: Performance is relative to baud rate.

To enter a value in 0.1s increments use the numerical keypad.

Once selected

Message display now shows

Note: This accepts all the settings for the RS232 Communications and puts into operation

to accept the RS232 settings

Standard Functions

RS232 Output Data Format

The output data from the RS232 is as follows:

The current axis data for the axes available on the system are transmitted.

For two axes systems, only two axes of data will be transmitted.

The data packet structure of 12 characters is defined as follows:

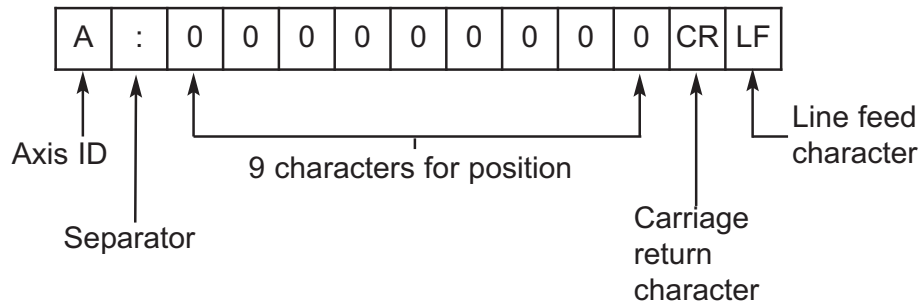

The **Axis ID** is the representation of the axis at the time of printing. This will be shown by 1 (1st axis), 2 (2nd axis) or 3 (3rd axis). Please see example below:

Example:

The example below shows an RS232 output from a 3 axis DP700.

1: 531.420
2: 497.615
3: 15.006

Mill Functions

This chapter details the Mill functions of the DP700. The mill functions use the plane setting from setup.

PCD / Bolt Hole Circle

The DP700 calculates positions for a series of equally spaced holes around the circumference of a circle. The message display prompts the user for various parameters it needs to do the calculations.

Once the DP700 completes the calculations, the axis displays show the distance to each hole. The operator works to Zero for each hole location. See example below.

How to navigate to PCD function.

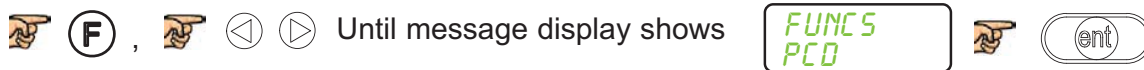

Example

Message display shows

PCD CENTRE	Enter centre co-ordinates (See using set mode P19)	125.250	◀	99.700	◀	▶	ent
PCD DIAMETER	Enter the diameter value (See using set mode P19)	150.000	◀	▶	▶	ent	
PCD HOLES	Enter the number of holes (See using set mode P19)	5	◀	▶	▶	ent	
PCD ANGLE	Enter the start angle value (See using set mode P19)	18	◀	▶	▶	ent	

Note: The PCD will be calculated from the 3 o'clock position, anti-clockwise. Enter the angle as a negative value if it is given as clockwise from 3 o'clock.

Note: At this point you can use the ◀ ▶ keys to navigate back and forth through the above menus.

PCD GO	▶	ent
-196.580	◀	PCD GO
-122.880	◀	HOLE 01

Note: The numbers appear as negative values because the operator works to zero.

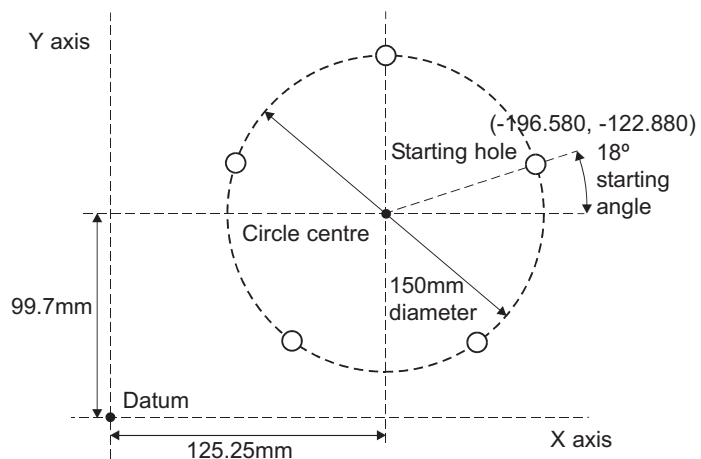

Navigate through the sequence of holes by using ◀ ▶ keys

The maximum number of holes is 999

Mill Functions

Line Hole

The DP700 calculates positions for a series of equally spaced holes on a line. The message display prompts the user for various parameters it needs to do the calculations.

Once the DP700 completes the calculations, the axis displays show the distance to each hole. The operator works to zero for each hole location. See example below.

How to navigate to line hole function.

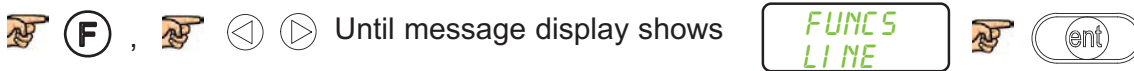

Example

Message display shows

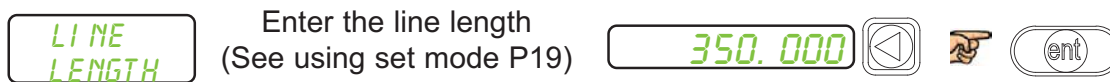
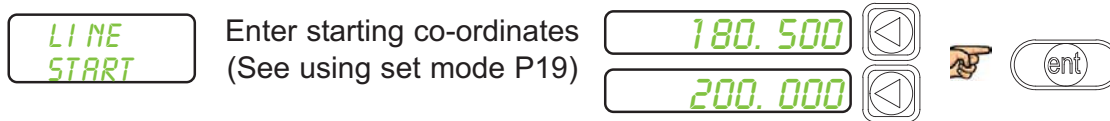

Note: length is the total length of the line hole sequence, not the distance between adjacent holes

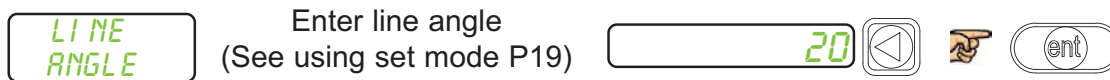
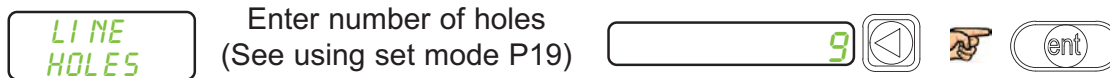

Note: At this point you can use the left and right arrow keys to navigate back and forth through the above menus.

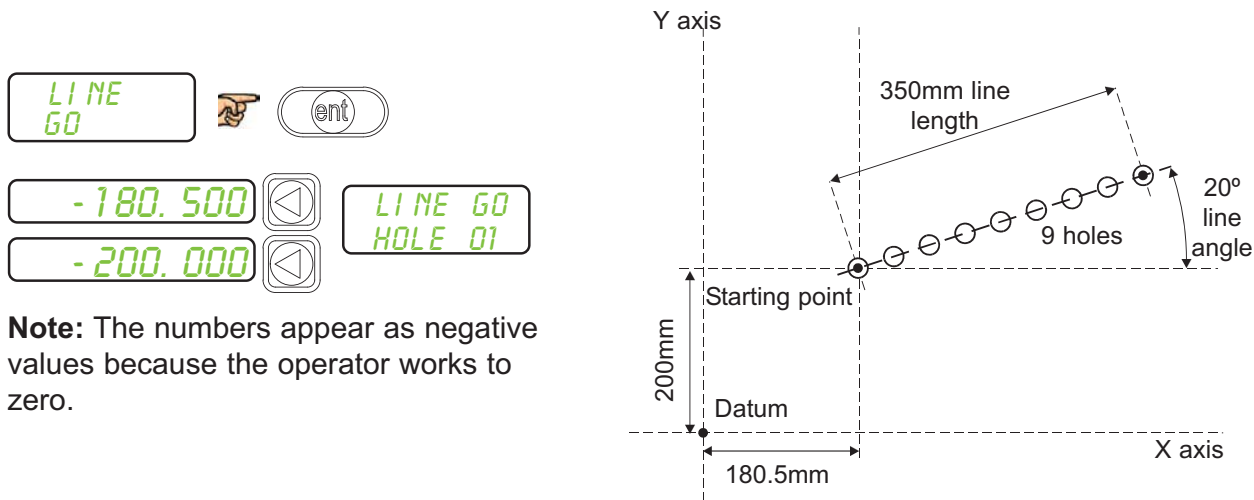

Note: The numbers appear as negative values because the operator works to zero.

Navigate through the sequence of holes by using left and right arrow keys

The maximum number of holes is 999

Mill Functions

Arc Contouring

The DP700 calculates positions for rough machining an arc or radius. The message display prompts the user for various parameters it needs to do the calculations.

Once the DP700 completes the calculations, the axis displays show the co-ordinates, which are point to point positions along the arc. The operator works to zero for each hole location. See example below.

How to navigate to arc contouring function.

👉 **F** , 👉 ⏪ ⏩ Until message display shows FUNCS
ARC 👉 ent

Example

Message display shows

ARC CENTRE	Enter centre co-ordinates (See using set mode P19)	3.35000	⏪	👉	ent
		2.36000	⏪	👉	ent
ARC RADIUS	Enter the arc radius (See using set mode P19)	2.70000	⏪	👉	ent
ARC START	Enter starting point (See using set mode P19)	2.25000	⏪	👉	ent
		4.82600	⏪	👉	ent
ARC END	Enter end point (See using set mode P19)	5.35000	⏪	👉	ent
		4.17400	⏪	👉	ent
ARC TOOL DIA	Enter tool diameter (See using set mode P19)	0.50000	⏪	👉	ent
ARC ARC TYPE	Selects internal or external cut	INT	⏪	👉	ent
ARC MAX CUT	Enter maximum cut (See using set mode p19)	0.15000	⏪	👉	ent

Note: At this point you can use the ⏪ ⏩ keys to navigate back and forth through the above menus.

ARC
GO

👉
ent

-3.34079	⏪	ARC GO
-4.81000	⏪	HOLE 01

Note: The numbers appear as negative values because the operator works to zero.

Navigate through the sequence of holes by using ⏪ ⏩ keys

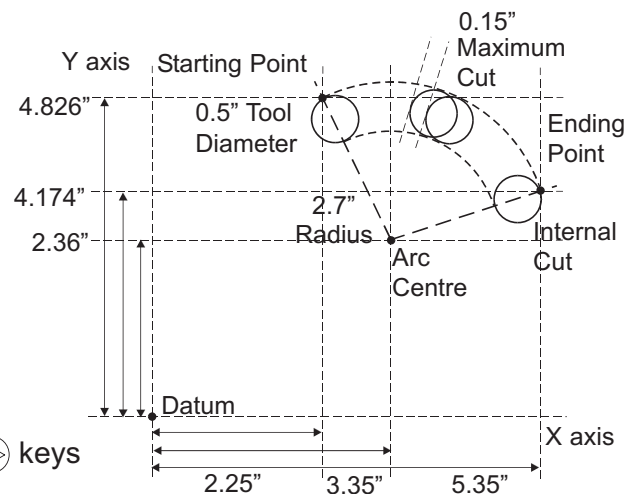

Mill Functions

Polar Co-ordinates

The Polar co-ordinate function enables the operator to convert the displayed data from the conventional cartesian co-ordinates (X,Y) to polar (length + angle) co-ordinates for any plane XY,XZ or YZ. See example below.

How to navigate to Polar co-ordinate function.

  Until message display shows

R 116.56
R 22.361

Note: Figures in box will vary depending on current position.

Example

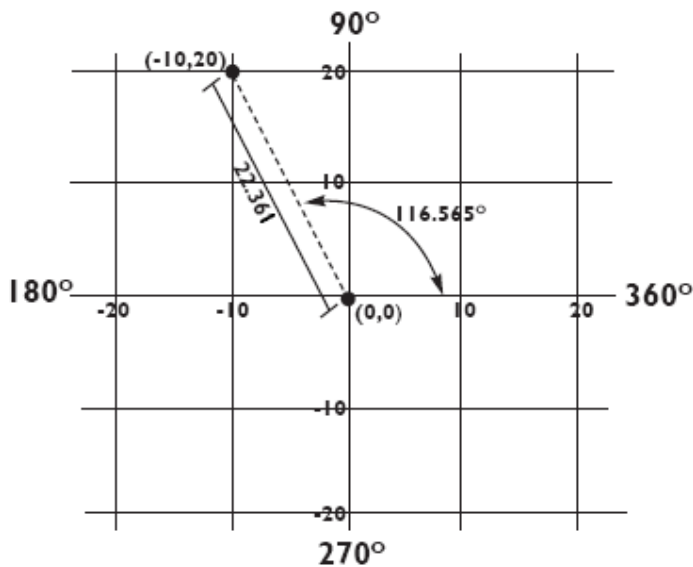
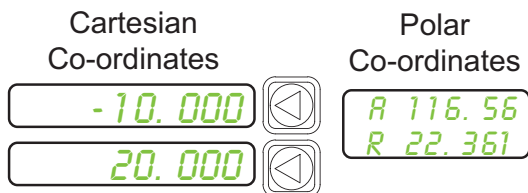

Lathe Functions

This chapter details the Lathe functions of the DP700.

Tool Offsets

The Tool Offset function allows the operator to enter and store offsets for a range of tools. This enables the operator to change tools without resetting absolute zero or datum. Using tool offsets ensures that diameter and length measurements will remain consistent after tool changes. This speeds up tool changes and increases productivity as it eliminates the need for the operator to stop and manually measure the diameter.

The number of Tool Offsets available is 50. This large number allows tools to be grouped where more than one set is used. For convenience, it is highly recommended that tools are physically marked with their corresponding tool number.

There are two ways to set tool offsets, teach mode and program mode.

How to navigate to the tool offset function.

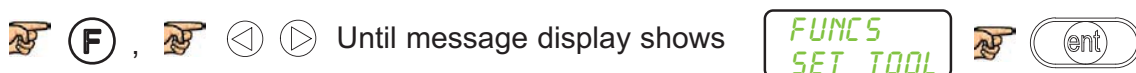

Teach Mode



Display will now show

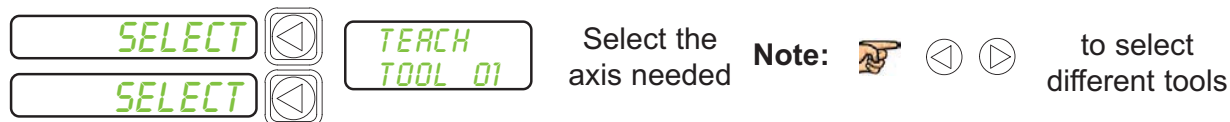

Display will show



Take a skim cut if X axis is selected, or take a face cut if Z axis is selected, then press **ent**.

Display will show



Measure the part with an accurate gauge and enter this value using the numeric keypad.

Repeat the above process for all the tools required.

Press **F** to exit tool set mode.

Lathe Functions

Program Mode

Display will show



Display will now show



Take a skim cut if X axis is selected, or take a face cut if Z axis is selected



Note: Tool must not be moved off the part after taking the cut.

User needs to enter the difference between measured diameter and readout value

Repeat the above process for all the tools required.



 **F** to exit tool set mode

Using Tool Offsets

 **i** Until message display shows 

The message window displays which tool is in use



   To scroll through different tools, or enter tool number on numerical keypad at any time.

Lathe Functions

 **This function only applies to units with software version 1.1.0 and above.**

Multiple Tool Datums



The Multiple Tool Datum function offers several advantages when compared to the standard Tool Offset function.



- **Multiple Datums** - Each tool has its own independent datum (tool datum)
- **Quick Tool Edits** - Changes can be made on the fly, with live position display

Application

Several tools are required for work on a particular piece. For example there might be a roughing tool, a finishing tool, a thread cutting tool, ID boring tool, etc. A separate datum can be set for each tool. Changing one tool does not affect the other tools.

Using Multiple Tool Datums





  Until message display shows 

  Until set mode is selected 

   to change tools. Current tool # is displayed in the message window

Setting Tool Datum

  of axis required  will be displayed

   to select  Enter desired numerical position value  

Repeat as necessary for other tools

A free software upgrade is available for units with a previous software to V1.1.0. Please contact Newall for further instruction.

Lathe Functions

Taper Function

The taper function shows the angular displacement of the displayed (X,Z) position.

How to navigate to Taper function.

  Until message display shows 

Note: Figures in box will vary depending on current position.

Example

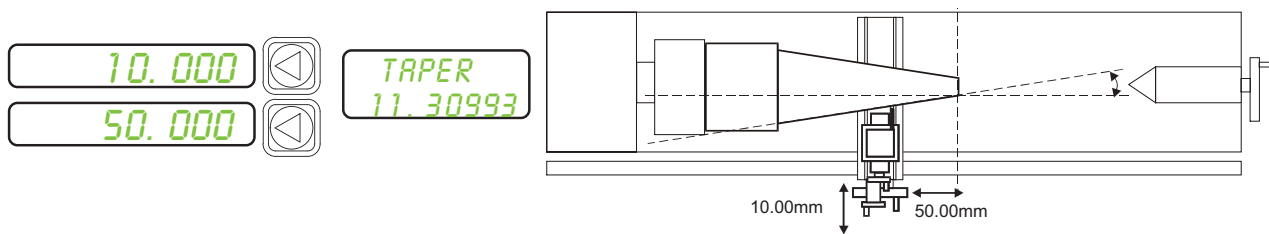

Touch tool to one end of the taper and zero both axes, then touch the tool on the other end of the taper. Message window will now display the taper.





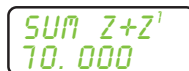

Summing Function

The summing function allows the sum of two selected axes to be displayed.

How to navigate to Summing function.

  Until message display shows 

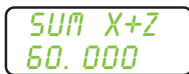
Note: Figures in box will vary depending on current position.

   to scroll through sum options  

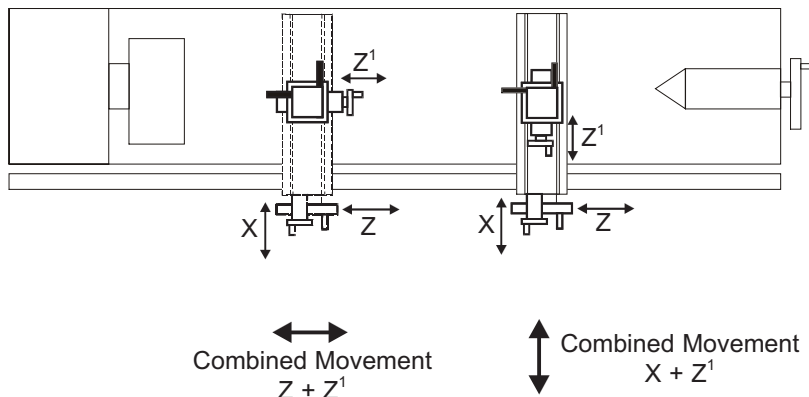

Trouble Shooting Guide

Symptom	Solution
The display is blank	<ul style="list-style-type: none"> • The DP700 maybe in sleep mode. press any key to exit sleep mode • Check that the power supply is correctly connected to a working mains outlet • Check that the power supply cables are not damaged • Check that the power supply voltage is 15 - 24Vdc $\pm 10\%$ • Check the power supply indicator is illuminated on the front of the DP700.
The display works, but resets from time to time without any keys being pressed.	<p>Either the supply voltage is too low, or the power supply or mains supply has an intermittent fault.</p> <ul style="list-style-type: none"> • Check that the power supply voltage is 15 - 24Vdc $\pm 10\%$. • Check that all the connections are secure.
The display works, but gives erratic readings, the last digit jitters or the measurements jump to new figures unexpectedly.	<p>There may be a poor earth (ground) connection. Both the DP700, and the machine on which it is installed, must have proper earth (ground) connections.</p> <p>There may be a problem with the encoder.</p>
The unit does not respond to any key presses.	Disconnect the DP700 from its power supply, wait 15 seconds and then reconnect.
'no Sig' or 'SIG FAIL' appears in the display.	<p>This indicates that the unit is not receiving a proper signal from the encoder.</p> <ul style="list-style-type: none"> • Check that the encoder connections are secure. • Check that there is no damage to the connectors or to the encoder. • Switch the DP700 off and back on again. • Swap the encoder to another axis to confirm whether the encoder or the DP700 is at fault.
Readings are incorrect.	<ul style="list-style-type: none"> • Check the Encoder Type to ensure it is correct. • Check the Radius / Diameter setting. The Diameter setting causes the axis to read double. • Check the Error Compensation factors. • If using the Segmented Error Compensation, verify the datum position. • Swap the encoder to another axis to confirm whether the encoder or the DP700 is at fault. • Check that there is no damage to the encoder or its cable. • Check that the encoder is fixed firmly and aligned correctly, as described in the Spherosyn / Microsyn Installation manual. • Check that there is no binding on the scale. With the scale brackets slightly loosened, you should be able to slide the scale back and forth with minimal resistance. • If you have a Spherosyn scale, check that the scale is not bent, by removing it and rolling it on a flat surface.

If the solutions suggested above do not solve your problem, contact Newall for further instruction.

To swap encoders to trace a fault:

1. Check that the two axes are set to the correct encoder types.
2. Disconnect the DP700 power supply.
3. Disconnect the encoder from the malfunctioning axis and move to a working axis.
4. Reconnect the DP700 power supply and turn on.

If the fault stays with the same encoder, then the encoder is at fault. If the fault does not follow with the encoder the DP700 is at fault.

Providing you have not moved the machine more than 6.3mm (0.25") for a Spherosyn Encoder or 2.5mm (0.1") for a Microsyn Encoder, switching the power off and back on again does not lose the datum position.

EUROPE

Newall Measurement Systems Ltd.

Technology Gateway, Cornwall Road
South Wigston, Leicester LE18 4XH
United Kingdom

Tel: +44 (0) 116 264 2730

sales@newall.co.uk

www.newall.co.uk

AMERICAS

Newall Electronics Inc.

1803 O'Brien Rd
Columbus, Ohio 43228 USA

Tel: +1 614 771 0213

CHINA & TAIWAN

Sensata Technologies China Co., Ltd.

BM Intercontinental Business Center
30th Floor

100 Yu Tong Road

Shanghai 200070

People's Republic of China

Tel: +86 212 2306 1500

SINGAPORE AND KOREA

Sensata Technologies Co., Ltd.

3 Bishan Place #02-04

Singapore 579838

Tel: +65 647 86 867

JAPAN

Sensata Technologies Japan Ltd.

Shin Yokohama Square Bldg, 7F
2-3-12 Shin-Yakohama, Kohoku-ku
Yokohama-shi

Kanagawa 222-0033 Japan

Tel: +81 45 277 7120

For more information about this or any of our products
please contact us at sales@newall.com or visit www.newall.com



DP7001016EN
023-81380-UK/2