

Model Bilgisi

Sipariş Kodu	WSGBOX-01
--------------	-----------

Performans Özellikleri

İşlemci	32bit RISC Cortex-A9 1GHz
Depolama	512 MB DDR3 + 4 GB eMMC

Yapısal Özellikler

Kasa Rengi	Siyah
Kasa Malzemesi	Metal
Kasa Boyutu	133 mm * 104 mm * 30,2 mm
Montaj	DIN ray kurulumu (35mm), VESA braket kurulumu (75 * 75mm)
Ağırlık	0,47kg

Bağlantı Portları

Ekran Çıkışı	1 * HDMI V1.4 FHD (1920 * 1080 @ 60Hz)
Genişletilebilir Hafıza	2 * USB Host
Ethernet	1 * 10 / 100M Ağ Bağlantı Noktası
Seri Haberleşme Portları	COM0 : PLC RS232/RS422/RS485 COM1 : PLC RS485 COM2 : PC/ PLC RS232
IO Bağlantı Noktası	2 Dijital Giriş (Programlanabilir, Standart 24V Kaynak Tipi) 3 Dijital Çıkış (Programlanabilir, Standart 24V Kaynak Tipi)

Genel Özellikler

- Cortex-A9 İşlemci 512MB DDR3 + 4 GB eMMC Memory
- HDMI V1.4 FHD (1920*1080 @ 60Hz) Çıkış
- 2 Kanal USB Host Port
- 1 Kanal 10/100M Ethernet Port
- 3 Kanal Seri Haberleşme Portu
- COM0: PLC RS232 / RS422 / RS485
- COM1: PLC RS485
- COM2: PC / PLC RS232
- 2 Kanal Dijital Giriş, 3 Kanal Dijital Çıkış



Kurulum (Cihaz Ölçüleri)

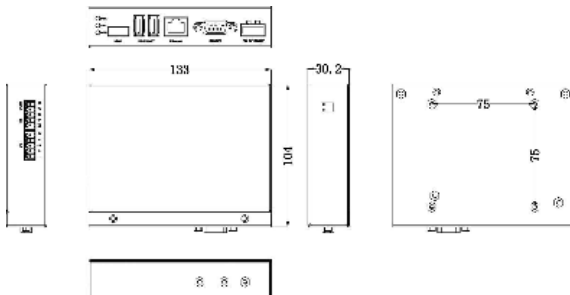

Çevresel Özellikler

Çalışma Sıcaklığı	0 ~ 50 °C
Çalışma Nemi	% 10 ~ 90 Bağıl Nem (Yoğuşmasız)
Depolama Ortam Sıcaklığı	-30 ~ 80 °C
Depolama Ortam Nemi	% 10 ~ 90 Bağıl Nem (Yoğuşmasız)
Sinüzoidal Titreşim Testi	10 ~ 25 Hz (Y ve Z Yönlerinde 2G / 30 dakika)
Soğutma Modu	Doğal Hava Soğutma

Elektrik Özellikleri

Anma Gücü	2,4 W
Anma Gerilimi	24VDC
Giriş Aralığı	10V ~ 28VDC
İzin Verilen Güç Kaybı	<3 ms
İzolasyon Direnci	>50MΩ (500VDC)
Dayanım Gerilimi Testi	500VAC 1 Dakika

Ürün Sertifikası

Koruma Seviyesi	IP20
-----------------	------

Kullanma Kılavuzu



1. Kurulum Notları

1.1 Ortam Şartları

Çalışma sıcaklığı: 32°F - 122°F (0~50°C).

Aşağıda belirtilen yerlerde kullanmayınız:

- Güneş ışığını direk geldiği
- Sıcaklık ve nem değerlerinin belirtilen sınırlarda olmadığı
- Isı farklarının ani değişerek nem oluşan ortamlarda
- Aşındırıcı ve yanıcı gaz bulunan ortamlarda
- Tozlu, kirli tuzlu ve demir tozu yoğun olan ortamlarda
- Su yağ gibi sıvıların sıçrama durumu olan ortamlarda
- Aşırı titreşim olan ortamlarda

Aşağıda belirtilen yerlerde koruyucu önlem alınız:

- Elektrostatik veya diğer gürültü türlerinin bulunduğu yerler
- Güçlü elektromanyetik gürültü olan yerlerde
- Zararlı ışınların olduğu ortamlarda

1.2 Güç Gereksinimleri

- Giriş gerilimi :DC21 V~DC28V.
- Anahtarlamalı güç kaynağı ile cihaz arasında yeterli mesafe olduğundan ve gerekli topraklama yapıldığına emin olunuz
- DC ve AC sinyallerin izoleli olduğundan emin olunuz

Note:
Dahili sigorta, aşırı voltaj durumunun zarar görmesini önler, ancak dahili elektronik bileşenlerin hasar görmediği garanti edilmez

2. Kurulum

2.1 Cihaz ölçüleri

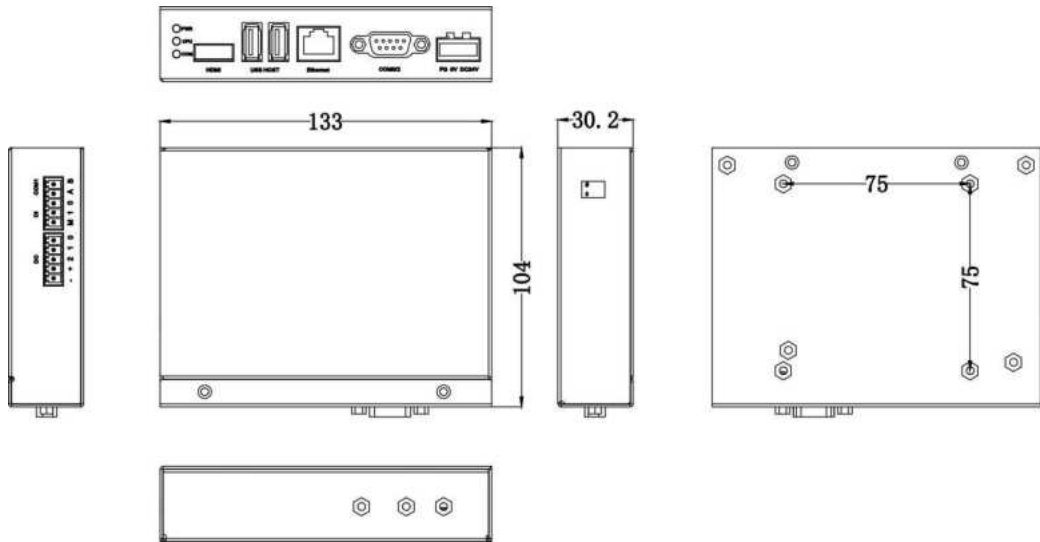

2.2 Bağlantı Tipi

DIN ray ve Duvar tipi

1. DIN ray (35mm)

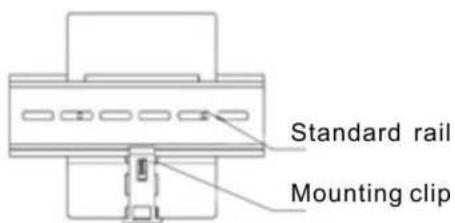

2. VESA Duvar Tipi (75*75mm)

3. Harici Bağlantılar

3.1 DIP

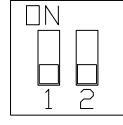

SW1	SW2	Çalışma modu
ON	ON	Sistem Menüsü
OFF	ON	Kullanılmıyor
ON	OFF	Update
OFF	OFF	Çalışma modu

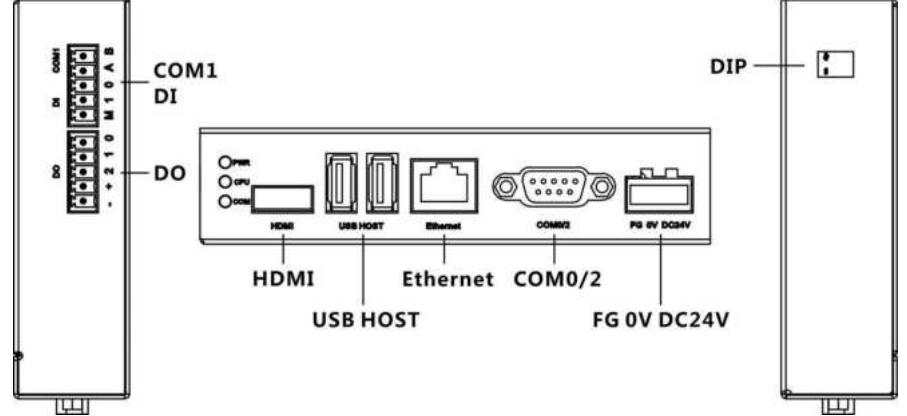

3.2 HDMI

Bağlantı	HDMI V1.4 port
Port Fonksiyonu	Bu bağlantı noktası 1920 * 1080 çözünürlüğü destekleyen ekran cihazıyla bağlantı için kullanılabilir. Not: HDMI dönüştürücüsüyle HDMI kullanırken, dönüştürücü harici beslemeli olmalı ve harici besleme verilmelidir.

3.3 USB HOST 1/USB HOST 2

Bağlantı	Standart USB kablosu ile bilgisayara bağlayınız.
Port Fonksiyonu	Standart USB kablosu ile bilgisayara bağlayınız Klavye, fare, yazıcı ve flash disk bağlama portudur. Flash disk ile program yükleme ve çekme yapılabilir.

3.4 Ethernet

Bağlantı	CAT5 UTP Kablo
Port Fonksiyonu	Bağlantı noktası, program yüklenmesi / indirilmesi, sistem parametrelerinin ayarlanması ve çevrimiçi yapılandırma simülasyonları için kullanılabilir. Bir HMI ağı oluşturmak için Ethernet üzerinden birden fazla HMI bağlayabilir. Ayrıca, Ethernet üzerinden HMI ve PLC arasındaki iletişimi ve Ethernet portu üzerinden bir PC ile iletişim kurabilir.

Fabrika ayarlarında WSGBOX-01'in default değerleri IP'si 192.168.0.253 Mask: 255.255.255.0 Gateway:192.168.0.1'dir.

3.5 COM0/COM2

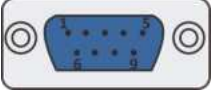

COM0/COM2 portları için Pin bağlantı uçları. COM0 RS232/RS485, COM2 RS232 destekler.

Pin	Sinyal	PLC (COM0) [RS-422]	PLC (COM0) [RS-485]	PLC (COM0) [RS-232]	PC/PLC (COM2) [RS-232]
1	Rx-(B)	RS422 R-	RS485 B		
2	RxD_PLC			RS232 RxD	
3	TxD_PLC			RS232 TxD	
4	Tx-	RS422 T-			
5	GND	Toprak			
6	Rx+(A)	RS422 R+	RS485 A		
7	RxD_PC				RS232 RxD
8	TxD_PC				RS232 TxD
9	Tx+	RS422 T+			

3.6 GÜÇ

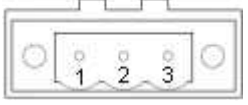

Pin#	Sinyal
1	FG
2	0V
3	DC24V

3.7 DI& COM1

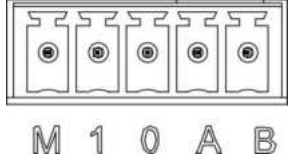

Bağlantı diyagramı

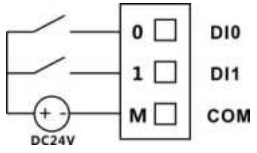

Pin#	Sinyal	Açıklama
B	COM1_485-	COM1 portu RS485 destekler
A	COM1_485+	
0	Giriş DI0	Giriş Gerilimi:11V-68V DI0~DI1: LB9430~LB9431
1	Giriş DI1	
M	Orta Uç	

3.8 DO

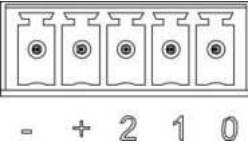

Bağlantı diyagramı

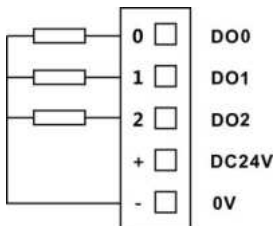

Pin#	Signal	Description
0	Çıkış DO0	Max. 200mA.PNP transistor çıkış DO0~DO2: LB9450~LB9452
1	Çıkış DO1	
2	Çıkış DO2	
+	Çıkış 24VDC	Max. 500mA. 24VDC çıkış
-	0V	

GMT Endüstriyel Elektronik San. ve Tic. Ltd. Şti.

Tel : +90 216 668 0006 Pbx. Fax : +90 216 668 000

url : www.gmtcontrol.com

Installation Instruction



1. Installation Note

1.2 Environmental Requirement

Operating temperature: WSGBOX-01 HMI can work stably in most industrial environments that the temperature between 32°F to 122°F (0~50°C).

Please do not use in the following places:

- Places direct in sunlight
- Surrounding temperature and humidity beyond the specifications
- Places of temperature changes sharply and easily cause condensation
- Places that exist corrosive gas and combustible gas
- Places of much dust, dirt, salt and iron powder
- Places that will be splashed water, oil and drugs
- Places that bring direct vibration and shock to host

Please take shielding measures in the following places:

- Places that exist electrostatic or other kinds of noise
- Places of strong electromagnetic
- Places that may be exposed to rays
- Places near the power

1.3 Power Requirement

- Input voltage: DC21 V~DC28V.
- Particularly note that there must be enough distance between this product and converters or switch mode power supply. Make sure that the input and output cables of that kind equipment are shield cable and the shielding network is connected with the ground.
- Make sure that the DC power and AC power is isolated.
- Do not use common power with perceptual load or input circuit of the controller.

Note: An internal fuse will prevent damage for over voltage condition, however it isn't guaranteed the internal electronic components are not damaged.

2. Installation Description

2.1 Dimensional Drawing

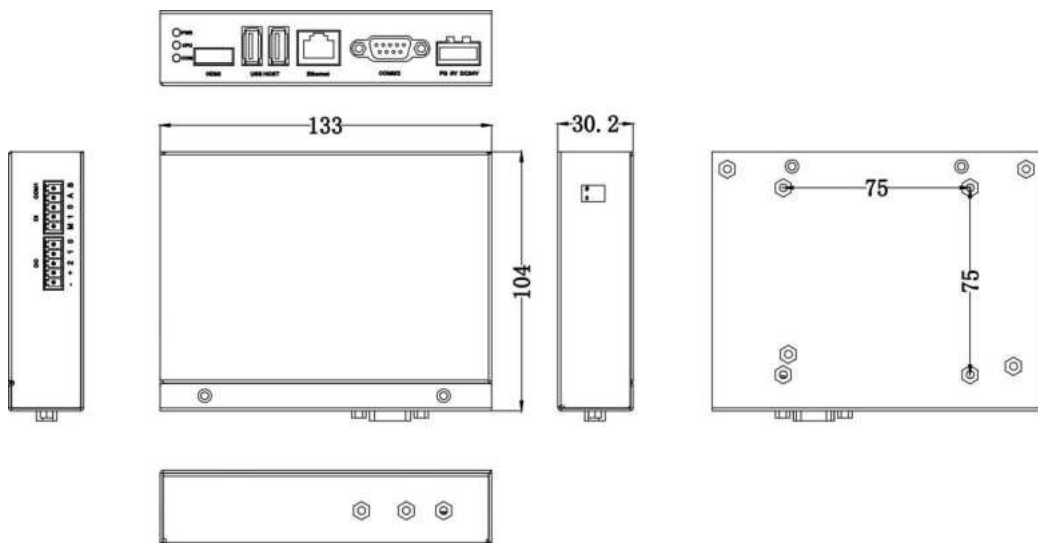

2.2 Installation Instructions

Two methods of installation for xF-SiHMI01: supported by DIN rail or bracket.

3. DIN rail(35mm)

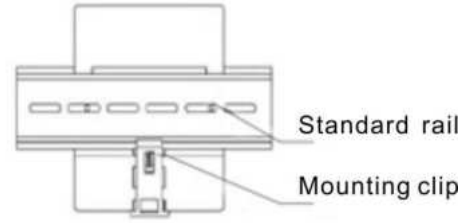

4. VESA bracket(75*75mm)

3.External Interface

3.1 DIP

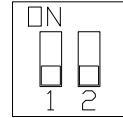

SW1	SW2	Working pattern
ON	ON	System Setup
OFF	ON	Reserved
ON	OFF	Hardware update
OFF	OFF	Operating Mode

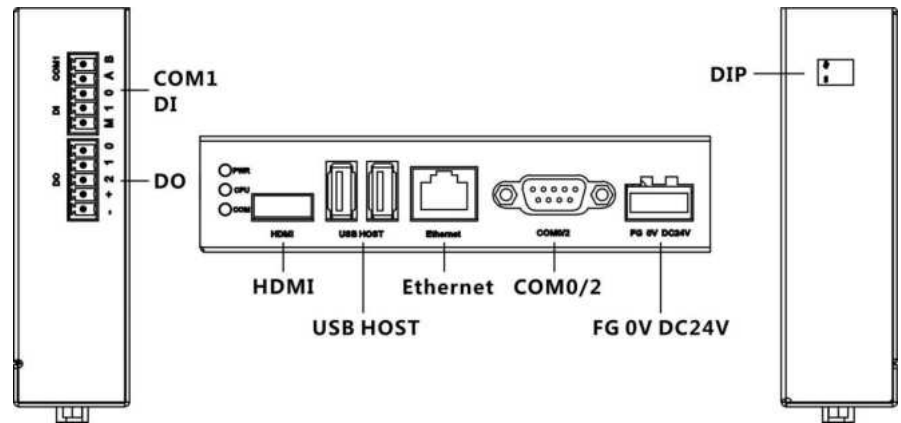

3.2 HDMI

Connection	HDMI V1.4 port
Port Function	This port can be used for connect with display device which supports 1920*1080 resolution. Note: When using HDMI with VGA converter, the converter needs to be powered independently.

3.3 USB HOST 1/USB HOST 2

Connection	Connect with USB interface devices or U disks
Port Function	This interface can be connected with USB keyboard, mouse and printers, and the U disk can be used for user's configuration uploading/ downloading as well as data storage.

3.4 Ethernet

10M/100M adaptive Ethernet RJ45 port.

Connection	With CAT5 UTP cable connected to the Ethernet device.
Port Function	The port can be used for upload/download of HMI configuration, setting of system parameters and online simulations of configurations. It can connect multiple HMIs via the Ethernet to form an HMI network. Furthermore, it can implement communications between HMI and PLC via the Ethernet, as well as communications with a PC via the Ethernet port.

The default values of the factory settings; WSGBOX-01 are IP: 192.168.0.253 Mask: 255.255.255.0 Gateway: 192.168.0.1

3.4 COM0/COM2

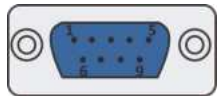

Pin assignment of the 9-pin male, D-SUB, COM0/COM2. **Note:** RS232/485/422 communication functions are supported by COM0.COM2 supports RS232 communication function.

Pin	Signal	PLC (COM0) [RS-422]	PLC (COM0) [RS-485]	PLC (COM0) [RS-232]	PC/PLC (COM2) [RS-232]
1	Rx-(B)	RS422 R-	RS485 B		
2	RxD_PLC			RS232 RxD	
3	TxD_PLC			RS232 TxD	
4	Tx-	RS422 T-			
5	GND	Signal ground			
6	Rx+(A)	RS422 R+	RS485 A		
7	RxD_PC				RS232 RxD
8	TxD_PC				RS232 TxD
9	Tx+	RS422 T+			

3.6 POWER

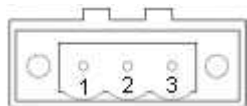

Pin#	Signal
1	FG
2	0V
3	DC24V

3.7 DI& COM1

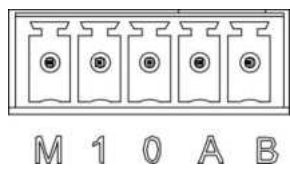

Wiring diagram:

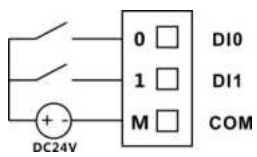

Pin#	Signal	Description
B	COM1_485-	RS485 communication functions are supported by COM1
A	COM1_485+	
0	Input DI0	Sourcing input, 11V-68V DI0~DI1: LB9430~LB9431
1	Input DI1	
M	Input Common port	

3.8 DO

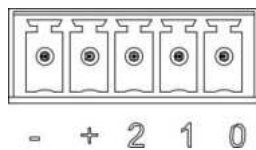

Wiring diagram:

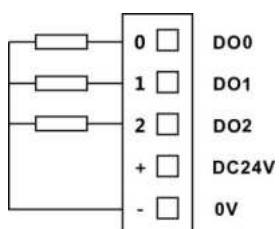

Pin#	Signal	Description
0	Output DO0	Sourcing output(Output level should be consistent with supply voltage), no more than 200mA. DO0~DO2: LB9450~LB9452
1	Output DO1	
2	Output DO2	
+	Output 24VDC	Provide 24VDC output (be consistent with power input voltage), no more than 500mA.
-	Output 0V	